



INSTRUCTION MANUAL

UMP3-1

With Micro4 Controller

CONTENTS

ABOUT THIS MANUAL	1
INTRODUCTION	1
Notes and Warnings.....	2
Parts List.....	3
Unpacking.....	3
INSTRUMENT DESCRIPTION	4
Setting Up the UMP3	5
1. Mounting the Pump	5
2. Connecting the Controller	5
3. Connecting the Controller and Powering Up.....	6
4. Mounting the Syringe.....	6
Collar Stop Adjustment.....	6
Choosing a Syringe.....	7
Understanding the Display.....	8
Setting Infuse/Withdraw	9
Volume Set.....	10
Volume Counter.....	11
Rate Setting / Unit Time.....	12
Rate Units	13
Defining Other Syringes	16
OPERATING INSTRUCTIONS.....	18
A Sample Operation.....	18
Calibrating a Syringe.....	19
Volumetric Diameter Measurement Using a Calibrated Microscope	19
Analytical Balance Measurement of Volume	19
Calibration on the Pump	19
Computer Control.....	20
RS232 Commands.....	20
RS232 Query Commands.....	21
Troubleshooting RS232 Commands.....	22
RS232 Cable Pinouts	24
Foot Switch Connections.....	24
MAINTENANCE	24
Storage	25
Wet Autoclaving Syringes.....	25

ACCESSORIES.....	25
Syringes	25
Syringes with Beveled Needles	25
Replacement Needles	26
Syringes with Luer Fitting (No Needle).....	26
Additional Accessories.....	26
Replacement Parts	26
TROUBLESHOOTING	27
SPECIFICATIONS.....	29
REFERENCES	30
APPENDIX A: SYRINGE CONSIDERATIONS.....	31
Special Syringe Considerations ILS005.....	31
Using Teflon Tipped Syringes.....	32
APPENDIX B: NANOLITER 2010/MICRO4 VOLUME SETTINGS.....	33
Setting the Correct Volume on the Micro4.....	33
APPENDIX C: MICRO-STEPPING	34
Brief Operational Theory of Stepper Motors	34
Advantages of Microstepping	35
Disadvantages of Microstepping.....	35
When Should I Microstep?.....	35
Normal Stepping Example Calculations.....	36
Microstepping Example Calculations	36
DECLARATION OF CONFORMITY	38
INDEX.....	41
WARRANTY	43
Claims and Returns	43
Repairs.....	43

ABOUT THIS MANUAL

The following symbols are used in this guide:



This symbol indicates a CAUTION. Cautions warn against actions that can cause damage to equipment. Please read these carefully.



This symbol indicates a WARNING. Warnings alert you to actions that can cause personal injury or pose a physical threat. Please read these carefully.

NOTES and TIPS contain helpful information.



Fig. 1—The UMP3 is mounted on WPI's M3301 micromanipulator and TB-1 stand (not included). WPI's NanoFil™ gas-tight syringe system (not included) is mounted on the UMP3.

INTRODUCTION

WPI's **UltraMicroPump III (UMP3)** uses glass microsyringes to dispense microliter, down to nanoliter, sample volumes. Microsyringes are easily installed by placing the syringe barrel into the UMP3's clamps. The UMP3 accepts syringes from 0.5 μ L to 250 μ L.

With its microprocessor controller, **Micro4™**, this versatile injector can be useful for a wide range of applications including micro delivery of biochemical agents or dyes, and both *in-* and *ex-vivo* injection. The pump can be mounted directly onto a stereotaxic frame or micromanipulator.

Operating parameters for the **UMP3** are set with the **Micro4**. Up to four pumps may be independently controlled. User-defined operating parameters are stored in memory for instant recall when the unit is powered on.

An optional foot switch (WPI# 15867) can be plugged into an RS232 port on the rear of the controller for “hands free” start /stop operation. The same port may also be used to connect the controller to a computer or to some other device for TTL triggering.

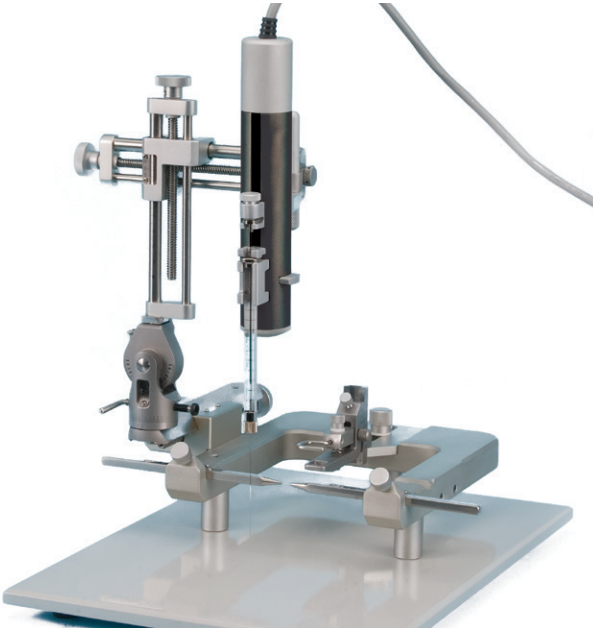

Fig. 2—UMP3 is shown mounted to stereotaxic frame (not included).

Notes and Warnings



CAUTION: Do not attempt to inject more fluid volume than is in the syringe. This can damage the syringe and seize the pump.



CAUTION: Do not autoclave. Sterilize with EtO or by wiping the exterior with alcohol or Cidex (WPI# 7364).



CAUTION: Do not wash or lubricate the pump head.

Parts List

After unpacking, verify that there is no visible damage to the instrument. Verify that all items are included:

(1) **UMP3** UltraMicroPump 3

(1) **Micro4** 4-Channel Controller

(1) Accessory Kit, including:

- 12V Power Supply
- Power Cable
- Phillips screwdriver #0

(1) Instruction Manual

NOTE: If a **UMP3** is ordered alone, it does not include the **Micro4** Controller. The kits (**UMP3-1**, **UMP3-2**, **UMP3-3**, **UMP3-4**) include the controller. **UMP3-1** includes one **UMP3**, **UMP3-2** includes 2 **UMP3** pumps, etc.

For a list of microsyringes available from WPI, see "Syringes" on page 25.

Unpacking

Upon receipt of this instrument, make a thorough inspection of the contents and check for possible damage. Missing cartons or obvious damage to cartons should be noted on the delivery receipt before signing. Concealed damage should be reported at once to the carrier and an inspection requested. Please read the section entitled "Claims and Returns" on page 43 of this manual. Please contact WPI Customer Service if any parts are missing at 941.371.1003 or customerservice@wpiinc.com.

Returns: Do not return any goods to WPI without obtaining prior approval (RMA # required) and instructions from WPI's Returns Department. Goods returned (unauthorized) by collect freight may be refused. If a return shipment is necessary, use the original container, if possible. If the original container is not available, use a suitable substitute that is rigid and of adequate size. Wrap the instrument in paper or plastic surrounded with at least 100mm (four inches) of shock absorbing material. For further details, please read the section entitled "Claims and Returns" on page 43 of this manual.

INSTRUMENT DESCRIPTION

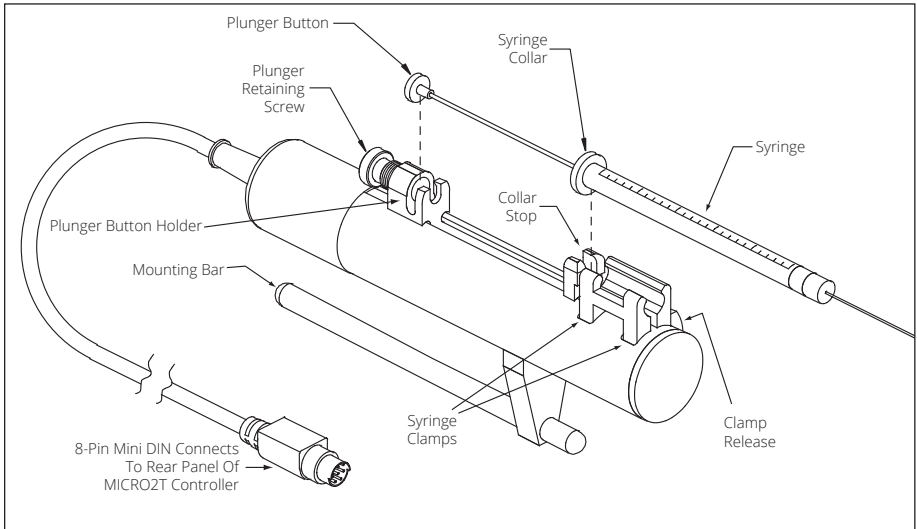

Fig. 3—The parts of the pump are labeled

Collar Stop—The syringe fits into the Syringe Clamp so that the Syringe Collar fits snugly against the Collar Stop. Always check the Collar Stop to verify that the syringe is held firmly. If necessary, adjust the collar stop placement using the Phillips head screw. Adjustment allows for ease of removal without damage to glass syringes.

Syringe Clamps—These clamps hold the syringe.

Clamp Release—Depress the Clamp Release Button to open the Syringe Clamps. To close the Syringe Clamps, let go of the Clamp Release Button.

Plunger Button Holder—The Plunger Button on the syringe fits into the Plunger Button Holder.

Plunger Retaining Screw—Tighten the Plunger Retaining Screw to hold the Plunger Button in place. Do NOT overtighten. The Plunger Retaining Screw should only be finger-tight.

Mounting Bar—This small rod is used for mounting the pump in a stereotaxic frame or on a micromanipulator.

Cable Connector—Plug the Cable Connector into the rear panel of the **Micro4** Controller.

Setting Up the UMP3

1. Mounting the Pump

The **UMP3** can be mounted directly onto a stereotaxic frame or a micromanipulator, using the mounting bar (Fig. 3). The mounting bar may be unscrewed and repositioned, if necessary. Two positions are available on the under side of the **UMP3** (Fig. 4).

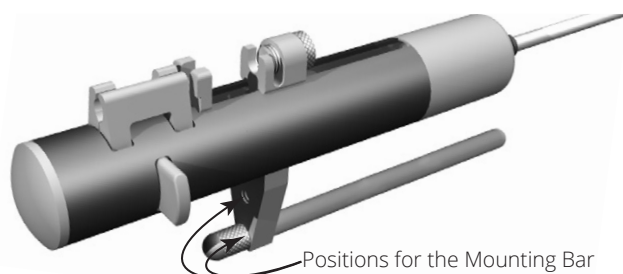

Fig. 4—Unscrew the mounting rod to reposition it.

WPI's **UMP3** fits directly into most standard stereotaxic frames. The **UMP3** mounting bar diameter is 7.90mm (0.311 in.). For example, **UMP3** fits directly into Kopf Standard 900 series frames (in place of 1770 electrode holder).

2. Connecting the Controller

Plug the **UMP3** cable into an output socket on the back of the **Micro4** controller (Fig. 5). Be sure to align the notch on the cable connector with top of the port on the back of the **Micro4**. Up to four pumps may be connected and independently controlled.

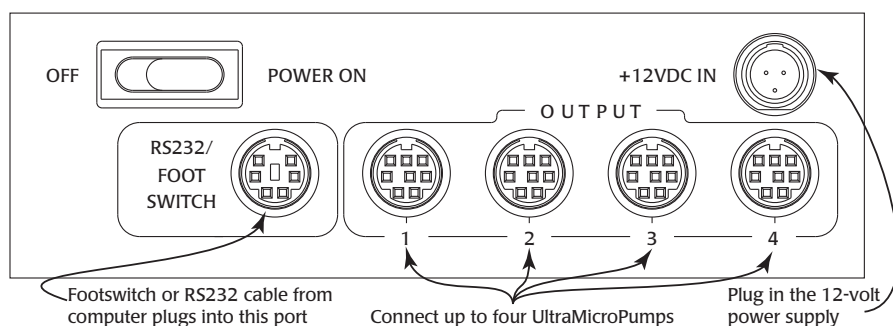

Fig. 5—On the rear panel of the **Micro4** controller, connect the footswitch, up to four **UMP3** pumps and the 12V power supply.



CAUTION: The connectors on the pump are polarized, and the pins may bend if the connector is not lined up properly with the port.

3. Connecting the Controller and Powering Up

1. Plug the 12-volt power supply into the rear panel of the **Micro4** (Fig. 5).
NOTE: The switchable power supply included with the controller automatically senses input line voltage between 100 and 240 V and converts it to 12V.
2. Connect the power cord to the power supply, and plug it into an electrical outlet.
3. If the foot switch (WPI# **15867**, not included) is needed, plug it into the RS232/ Foot switch port on the rear panel of the **Micro4** controller.
4. The power switch is located on the rear panel of the **Micro4**. Switch the **Micro4** on and verify that the LCD screen is illuminated.

NOTE: Before operating the UMP3, you must enter the parameters into the **Micro4** controller.

4. Mounting the Syringe

Syringes may be filled manually before mounting in the **UMP3** or filled by using the fast reverse function. (See "Operating Instructions" on page 18.)

1. Fill the syringe.
2. Place the plunger button of the filled syringe into the plunger button holder (leaving the plunger retaining screw loose).
3. Then, place the syringe collar into the collar stop (Fig. 3).
NOTE: Be careful not to damage the syringe collar during this installation.
4. Gently tighten the plunger retaining screw so that the plunger button is secure when the pump is activated. This allows for zero volume error during pump operation.

Axial Needle Alignment

In order to maintain a good syringe needle alignment (particularly along the same axis of the supporting bar), rotate the syringe body while placing it into the two clamps. This allows the syringe to seat properly and aligns it along the body of the pump for minimal slant offset.

If the collar stop clamp is too tight or too loose, the syringe needle alignment may be inaccurate.

Collar Stop Adjustment

If the collar stop is too tight to allow the syringe collar to insert easily, it can be adjusted.

1. Locate the Phillips-head adjustment screw for the collar stop. It is located immediately below and behind the collar stop, in the groove with the long drive screw. (See Fig. 6.)



Fig. 6— (Right) The UMP3 collar stop adjustment screw is located in the groove on the top of the UMP3.

2. With the #0 Phillips screwdriver, loosen this screw slightly (about 0.5 to 1 mm) to allow for a thicker collar. If necessary, grasp the collar stop and wiggle it backwards to move it.
3. Once the stop is backed out, adjust for a tight fit so the syringe body does not move when placed into the holder.
4. Gently re-tighten the screw in the new position.

NOTE: The plunger button holder may need to be retracted to access the adjustment screw.

Choosing a Syringe

First, the syringe should be chosen to inject no less than 5% of its volume at once. This is because the overall accuracy of the syringe itself is usually no greater than $\pm 3\%$, and the syringe internal diameter may deviate from location to location along the length of the syringe interior.

For example, a 100 μL syringe may be used for injections on the **UMP3** to volumes of 5 μL (5000nL) and higher with high precision and repeatability. Expecting this 100 μL syringe to inject less than 1 μL may prove difficult, if the syringe is not calibrated specifically on the pump.

Choosing the correct syringe for an injection is a very important consideration, due to accumulated errors of the syringe and the pumping method. A 1000nL injection from a 10 μL (10,000nL) syringe means the injected volume is 1/10th of the syringe's total volume. Theoretically, based on mathematics without any consideration of surface tension, heat, pressure, compressibility, silanization or air bubbles, the 3% error rate should yield a $\pm 300\text{nL}$ variance.

Second, the choice of the syringe should not exceed 1/10th – 1/20th the stated full volume of the syringe. The **Micro4-UMP3** system uses a stepper motor to move the syringe piston forward to inject the volume. It is best to allow the motor to step forward at least 10 steps to prevent errors in volume injecting. We recommend stepping no less than 10-100 steps for an entire single injection.

In the 10 μ L case above, a 1-step movement of the motor will inject a volume of 0.5276nL. For two steps to occur, a volume of 1.055nL will be injected. This may or may not be acceptable as the total error may exceed 1nL or nearly 0.1%. In this case, two steps is probably not enough resolution to accurately control the volume. Using this 10-step rule, the minimum acceptable injectable volume from this 10 μ L (10,000 nL) syringe is $0.527.6\text{nL} \times 10$ or 5.276nL.

NOTE: Each type of syringe yields a different value depending on its inside diameter and the volume per step.

For more information on syringes, see “When Should I Microstep?” on page 35.

Understanding the Display

Parameters are entered using the keys on the front panel of the **Micro4**. The **NUMBER** keys and the **SELECT** key are used to change parameters.

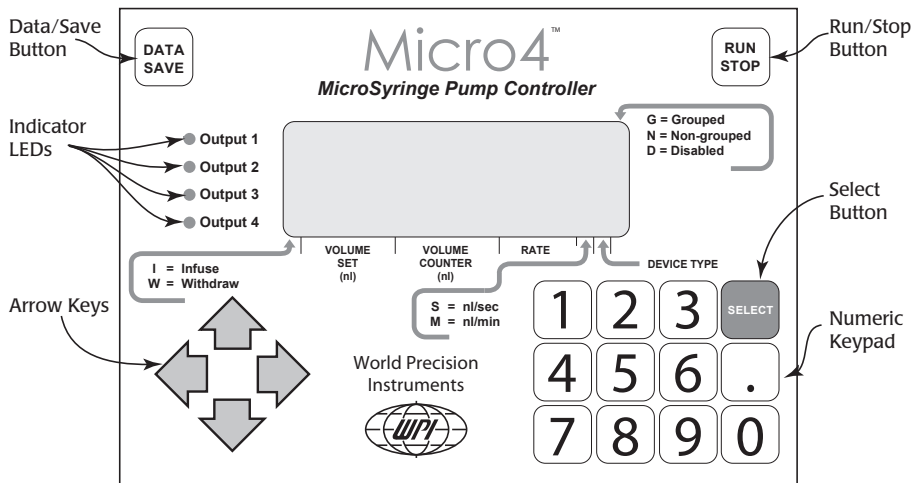

Fig. 7—The front panel of the Micro4 controller is used for setting parameters.

Data/Save Button– Saves all parameters on LCD display to memory. Next time the Ultra Microsyringe Pump controller is turned on, the last parameters saved will be displayed.

Indicator LEDs– When a pump is running, its corresponding LED is illuminated. For example, the LED next to Output 1 illuminates when pump one is operating. The LED flashes if no pump is attached and the channel is running.

Arrow Keys–These keys move the cursor around the display. The **LEFT** and **RIGHT ARROW** keys move the cursor on the LCD display to the desired position. The **UP** and **DOWN ARROW** keys select the channel (corresponding to the output channels on the rear of the instrument).

Run/Stop Button—Press this button to start or stop the pump(s).

Select Button—Use this button to toggle through the selected parameters: Infuse/Withdraw, Syringe Size, Rate Units (nL/sec or nL/min) and mode (Grouped, Non-grouped and Disabled).

Numeric Keypad—The keypad lets you enter settings for infusion and withdrawal rates and volumes.

Setting Infuse/Withdraw

The character displayed in the first field indicates the operating mode:

- **I** for Infuse
- **W** for Withdraw.

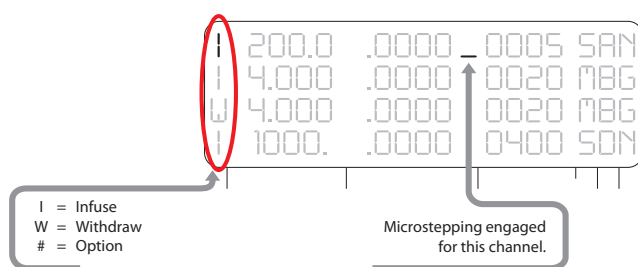

Fig. 8—The I (first character line 1) indicates that the pump on output 1 is infusing. The W (first character line 3) indicates that the pump on output 3 is withdrawing.

1. Press the Select button to place the cursor in the display.
2. Use the **ARROW KEYS** to position the cursor in the first field (infuse/withdraw) of the desired channel.

Options—While the cursor is in the infuse/withdraw field of any channel, you may enable or disable several options for that channel by pressing the appropriate number on the keypad.

1	Disable audible tones on all channels.
2	Enable audible tone on all channels. This is the default.
3	Set the run/stop key to “press and hold” mode. Pump operates as long as the run/stop key or foot switch is held down and stops when it is released. This action affects all channels.
4	Sets the run/stop key to “toggle” mode. Press and release the run/stop key to start or stop the pump. This action affects all channels.
5	Sets volume per step for syringe types not already preset in the Micro4 memory (See “Defining Other Syringes” on page 16).
6	Turn microstepping on.
7	Turn microstepping off. This is the default.

- To toggle between the infuse and withdraw modes, press **SELECT**.
- Press the Data/Save button to store the parameters in the controller's memory for future use.

NOTE: For more information on microstepping function, see "APPENDIX A: Syringe Considerations" on page 31.

NOTE: Functions 5, 6 and 7 are channel specific. The parameters for these functions may be changed while the pump is running.

Volume Set

The second set of characters on the display, the volume set field (Fig. 9), define the volume that is to be infused or withdrawn.

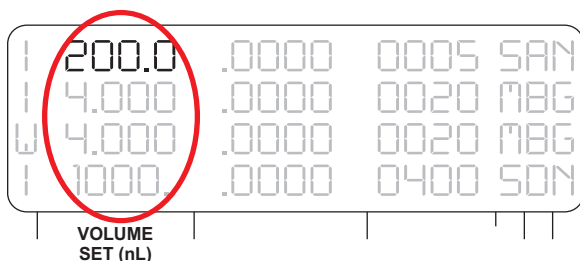

Fig. 9—Place the cursor in the volume set field of a channel and use the keypad to enter the desired value to be infused or withdrawn.

- Press the Select button to place the cursor in the display.
- To select the desired volume to be infused or withdrawn, position the cursor in the volume set field of the appropriate channel.
- Enter the numbers with the numeric keypad. The values shown on the LCD display are in nanoliters.
- Press the Data/Save button to store the parameters in the controller's memory for future use.

NOTE: For 10 μ L enter "10000". For 1.0 μ L enter "1000." Be sure to include the decimal point.

! **CAUTION: Syringe injection accuracy can vary.** Since every syringe in the microliter volume range has its own unique intricacies, verify and calibrate each syringe and log its characteristics for accurate injections. The **Micro4** controller has preset *types* of syringes to very accurately move the plunger button of the syringe a precise distance per injection.

Volume Counter

The third set of characters on the display, the volume counter field (Fig. 9), shows the real-time volume that has been dispensed on each channel. When the pump is running, this field is not editable. If the pump is not running, you may change this number.

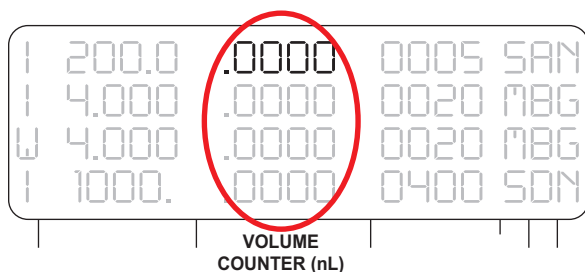

Fig. 10—The volume counter field shows the real-time volume that has been delivered on each channel.

1. Press the Select button to place the cursor in the display.
2. To change the volume counter while the pump is running, use the arrow keys to position the cursor in the volume counter field of the appropriate channel.
3. Use the keypad to enter the desired number. When the pumps starts again, the counter will continue from the value entered manually.
4. Press the Data/Save button to store the parameters in the controller's memory for future use.

Injections Beyond 99999nL (5 Digits In The Volume Field)

With a little mathematics, you may inject more than the volume counter display shows. By choosing a proportionally smaller syringe and calculating the length of the syringe that needs to be dispensed, you can command the controller to dispense the correct, proportionally larger volume. You may use any combination of syringe types and volume choices to displace a particular length, as long as the volume is noted and the injection speed does not exceed the rated value for that syringe volume. See “Fig. 10—The volume counter field shows the real-time volume that has been delivered on each channel.” on page 11.

For example, if you want to inject 150,000nL from a 500 μ L liquid-tight syringe, but the volume counter can not accept 150,000 as a number, then use this procedure.

1. Determine what percentage of the syringe volume you need to inject. In our example, $150,000\text{nL} / 500,000\text{nL} = 0.3$ or 30% of the syringe volume.
2. On the controller, select a syringe TYPE that can accommodate a proportionally reduced number of the same injection percentage. In our example, we might a select a syringe that is half the size (50%) as the one we are using.

If we use a TYPE H, a 250 μ L syringe, then when the controller shows a 75,000nL injection, it is really injecting 150,000nL from a 500 μ L syringe.

3. To verify the method:

Simply multiply the scale length of the syringe by the percentage of the syringe you need to inject. In this example, we multiply 30% by 60mm scale length to determine the actual distance travelled. $0.3 \times 60 = 18\text{mm}$

Divide the injection volume entered into the controller by the total volume of the syringe entered into the controller. In our example, $75,000/250,000 = 0.3$.

Then, multiply that percentage by the scale length of the syringe entered into the controller. In our example, $0.3 \times 60 \text{ mm} = 18 \text{ mm}$.

Rate Setting / Unit Time

The fourth set of characters define the rate of infusion or withdraw (Fig. 11).



Fig. 11—Place the cursor in the rate field of a channel and use the keypad to enter the desired rate value for the infusion or withdrawal.

1. Press the Select button to place the cursor in the display.
2. To select the rate for infusion or withdrawal, position the cursor in the rate field of the desired channel.
3. Use the keypad to enter the desired value. If the rate entered is too large for the selected syringe type, the highest possible value will be displayed in this field.
4. Select the rate units. See "Rate Units" on page 13.
5. Press the Data/Save button to store the parameters in the controller's memory for future use.

Rate Units

The fifth area of the display shows the rate at which the volume is dispensed. Two rate units are available: nanoliters per second (nL/s) and nanoliters per minute (nL/min.).

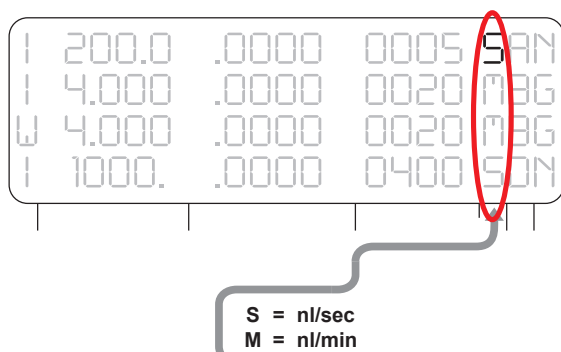

Fig. 12—The highlighted field shows the rate of infusion or withdrawal. In the example shown, the first and last channels are operating in nL/s and the second and third channels are running in nL/min.

1. Press the Select button to place the cursor in the display.
2. Position the cursor in this field of the appropriate channel.
3. Use the **SELECT** key to choose either **S** (nL/sec) or **M** (nL/min).
4. Press the Data/Save button to store the parameters in the controller's memory for future use.

Device (Syringe) Type

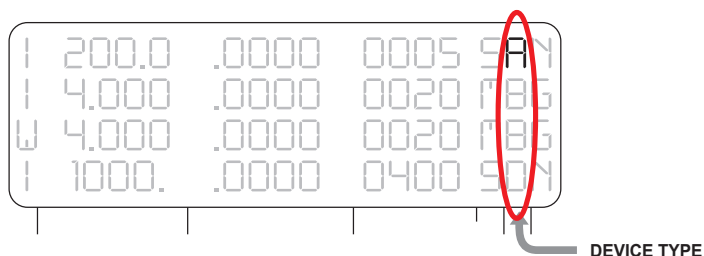

Fig. 13—The device type field is the second one in from the right. Use the Select button to choose the appropriate syringe type.

The volume per step and rate data for eleven microsyringes are already stored in **Micro4** controller's memory. To specify one of these syringes:

1. Press the Select button to place the cursor in the display.
2. Position the cursor in the device type field of the appropriate channel.
3. Use the **SELECT** key to change the syringe type to a letter (**A - P**) corresponding to that of the syringe in the table below.

NOTE: See the table that follows for information on the programmed syringe types. When using the **Micro4** to control a **Nanoliter 2010** pump, set the device type to **K**.

4. Press the Data/Save button to store the parameters in the controller's memory for future use.

Type	Syringe Volume	Scale Length (mm)	ID (mm)	nL / step REV K	Max. Rate nL /sec	Max. Rate Microstep nL /sec
A	0.5 µL	54.1	0.1085	0.0294	20	1
B	1.0 µL	54.1	0.1534	0.0587	40	2
C**	5 µL	54.1	0.343	0.2934	202	14
D	10 µL	54.1	0.485	0.5868	451	29
E	25 µL	60	0.73	1.329	1022	66
F	50 µL	60	1.03	2.646	2035	132
G	100 µL	60	1.46	5.315	4088	265
H	250 µL*	60	2.3	13.191	9999	659
I	500 µL*	60	3.26	26.501	9999	1325
J	1000 µL*		4.61	52.995	9999	2649
K	Nanoliter 2010†		0.48 plunger in 0.50 glass	2.3 nL /step (0.0005" step)	884	115
L	10 µL	60	0.4607	0.5293	407	29
M,N,O,P	User Defined			See page 16	custom rate‡	
**	ILS005		0.4856	0.5880 compensates for length as TYPE M		

* Gas-tight syringes are not recommended for **UMP3** in these volumes; instead, use a liquid-tight syringe to prevent drive motor damage or stalling.

** The ILS005 5µL syringe must use type M, N, O or P with a 0.5880 nL/step entry. See "Special Syringe Considerations ILS005" on page 31 for details.

† WPI's **Nanoliter 2010**, a nanoliter injector for the 2-70nL range, comes with its own simple controller but may also be driven by the **Micro4**. For more information, ask about WPI # **NANOLITER2010**.

‡ The custom syringe rate maximum is calculated internally and is determined by the nL/step value times 10000 and divided by 13. The microstepping maximum rate is nL/step *10000 / 200.

Syringe Stroke Length

The delivery of the **UMP3** is based on 60mm or 54.1mm syringes. Please note which syringe length you are using as a factor of 0.9016 may need to be applied to the volume to be injected in order to have a precise injection. For the ILS005, use the TYPE “M” values in the table below.

Maker	Syringe	Stroke Length	Use Type
WPI	NanoFil™ 10µL, 100µL	60 mm	L
Hamilton	1700 Series, 10µL	60 mm	L
Hamilton	700 Series 5 µL ,10 µL	54.1 mm	C, D
Hamilton	7000 Series	60 mm	M, N, O, P*
SGE	0.5 µL – 10 µL	54.1 mm	A, B, C, D
ILS 5 µL Luer tip	ILS005	28 mm	M, N, O, P*
SGE, Hamilton 700, Hamilton1700	25 µL – 500 µL	60 mm	E-L

Not all syringes from a particular series or manufacturer are usable on the UMP3 * See table on page 31.

Grouped/Non-Grouped/Disabled

For convenience in operating multiple pumps (whether of identical or various volumes), pumps may be grouped or non-grouped. This field is the last one on the far right side of the display (). Three mode options are available:

- **Grouped mode:** Syringe channels with “G” in this field are started or stopped when the **RUN/STOP** key is pressed while the cursor is located on any grouped channel.
- **Non-grouped mode:** When the cursor is positioned on a channel that is not grouped, indicated by the letter “N”, *only that channel* starts or stops when the **RUN/STOP** key is pressed.
- **Disabled mode:** When a channel is disabled, the line of data is hidden and the pump will not operate. No changes may be made to this channel while it is disabled. To re-enable it, move the cursor back to the Group/Non-group field and press the **SELECT** key. Then, the previously entered data is restored.



Fig. 14—The Group field appears in the far right column of the display. In this example, the first and last channels are grouped, the second channel is disabled, and the third one is not grouped.

1. Press the Select button to place the cursor in the display.
2. Use the arrow keys to position the cursor in the group field of the appropriate channel.
3. Press the **SELECT** key to toggle through three operating modes.
4. Press the Data/Save button to store the parameters in the controller's memory for future use.

Defining Other Syringes

Eleven microsyringes with volumes ranging from 0.5 μ L to 1000 μ L are already preset in the **Micro4**. These include syringe types **A** through **L**. See the syringe table on page 11). A microsyringe with a volume other than those preset may be entered as device type **M**, **N**, **O** or **P**. However, the volume per step must be user-defined.

- You may program the **M**, **N**, **O** and **P** custom syringes in any channel location (1, 2, 3, 4).
- The custom memory designator (M, N, O, P) must be entered in the TYPE column to program the memory.
- Press the #5 key with the blinking cursor on the Infuse/Withdraw location to write the new nL/step value to the memory. Then, press the Data Save key to retain that custom definition.
- Custom defined syringes **M**, **N**, **O** and **P** may be used in any channel position or multiple channels.
- The factory default values for these memory points are the TYPE "D" syringe (0.5868 nL/sec).

To define another syringe type:

1. Calculate the volume per step using the formula below. Syringe displacement is the distance between 0 and the maximum volume marked on the syringe in inches. Syringe volume is in nanoliters. ID is in millimeters.

Volume per Step = Volume inside the syringe (a cylinder) that is dispensed in a single step = $p r^2 \times d$ (r is the radius of the syringe diameter or ID/2, and d is the distance traveled in a step or 3.175 mm/step)

$$= (ID/2)^2 \times p \times 3.175\text{mm/step}$$

$$= (ID/2) \times (ID/2) \times 3.1415926 \times 3.175$$

The inside diameter (ID) of a syringe may be determined using the following formula:

$$ID = \text{SQRT} [\text{Volume}/(3.14159 \times \text{Length})] \times 2$$

where length is the visible marking on the syringe body (total length in mm) and volume is the full volume of the syringe in microliters.

For example, if you have a 60mm syringe with a 2.5 μ L volume, use the formulas above to determine its volume per step.

$$ID = \text{SQRT}[2.5 / (3.14159 \times 60)] \times 2 = 0.23032$$



$$\text{Volume/step} = (0.23032/2)^2 \times 3.14159 \times 3.175 = 0.1329\text{nL}$$



2. The Micro4 has four memory locations for a custom syringe (M, N, O or P). Move the cursor to the Type field and toggle to choose one of them.
3. Move the cursor to the Volume Set field for the desired channel and enter the calculated value. In our example, the value is 0.1329nL.
4. Then use the left arrow key to scroll the cursor to the first position on the LCD display and press the 5 on the numeric keypad. This sets your calculated definition for your type of syringe into the **Micro4** at the designated memory location (M, N, O or P).
5. Before proceeding, move the cursor back to the volume set field and re-enter the correct volume for the syringe on output channel 1. This may be any type — not necessarily type M, N, O or P.
6. Press the Data Save key to store the custom syringe definition.

NOTE: If you do not press the Data Save key, the information is lost when you turn the unit off.

OPERATING INSTRUCTIONS

When the pump runs, a series of beeps indicates that the pump is running. A lamp on the back of the **UMP** indicates that the pump is receiving a signal from the controller. As the pump runs, the counter increments as an indication of the plunger's motion. Multiple injections can be achieved by pressing the **RUN/STOP** button again after the pump has stopped.

  To run the pump in **Fast Forward** mode, press and hold the **RIGHT ARROW** key. Then, press **RUN/STOP**. The syringe pump will continue running as long as these two keys are depressed.

  To run the pump in **Fast Reverse** mode, press and hold the **LEFT ARROW** key. Then, press **RUN/STOP**. The syringe pump will continue running as long as these two keys are depressed.

A Sample Operation

1. Check the fit and seating of the syringe on the pump head. See “Collar Stop Adjustment” on page 6 for the collar fit.
2. Program the syringe TYPE into the **Micro4** controller. See “Fig. 10—The volume counter field shows the real-time volume that has been delivered on each channel.” on page 11.
3. Place a partially prefilled syringe on the pump.
4. Move the plunger button holder using the fast forward and fast reverse, as necessary, to align and capture the syringe plunger without withdrawing any air into the needle tip.
5. Center the syringe plunger and tighten the carrier screw.
6. Expel some fluid to ensure that there is no air in the syringe needle.
7. Infuse the required volume of fluid for the injection or for multiple injections.

 **CAUTION:** Be careful not to over run the maximum volume of the syringe or inject more than the total syringe filled volume.

8. Program the volume (always in nanoliters) into the controller.
9. Test the injection or prime the carrier play. The plunger carrier has a mechanical play of up to 100 μ m in each direction. This play corresponds to about 32 steps (100 μ m/3.175 μ m/step) of the motor. This should be considered when changing pump directions. This corresponds to 18.48nL on a 10 μ L syringe (34.49 steps/0.5868 nL/step). You need to compensate for this play by moving the carrier a like distance to ensure that the accurate volume is moved. See “Fig. 10—The volume counter field shows the real-time volume that has been delivered on each channel.” on page 11 for details on each syringe's volume per step value.
10. Apply the injection(s).

Calibrating a Syringe

Every syringe should be calibrated on the pump that it is being used with.

This gives you two things, verification of the error involved in the injection and the confidence that injection is correct.

Errors for micro volume syringes are rated at 1% to 3% of the full-scale volume. So, for a 10 μ L syringe injecting 10 μ L there may be a maximum error of $\pm 0.3\mu$ L if the injection takes place along the markings on the syringe barrel. When used in a specialized syringe pump like the **UMP3**, this same syringe is now defined by a fixed length and moved by a precision stepper motor. This can offer a very high degree of precision and repeatability. This same 3% error of the 10 μ L syringe can now be calibrated to deliver a reduced error of $\pm 0.5\%$ tolerance or better.

We will discuss a couple options for calibrating a syringe.

Volumetric Diameter Measurement Using a Calibrated Microscope

1. Using a microscope and a calibrated reticle or stage micrometer, inject an amount of water into a hydrated oil droplet
2. Using the reticle, measure the sphere.
3. Calculate the volume of the sphere ($V = [4/3] \times \pi r^3$) in nanoliters using the equation:

$$\text{Volume} = (D/2)^3 \times 3.1415926 \times (4/3) \times 1000\text{nL/mm}^3$$

D=Diameter in mm

Analytical Balance Measurement of Volume

1. Use an analytical balance to weigh the mass of an injected volume of water.
2. Calculate the volume in nanoliters. For pure water, 1g = 1mL at 4°C.

Calibration on the Pump

Once you have an accurate measurement of the dispensed volume, then you can make adjustments using one of the methods below.

- **Method 1:** Compare the injected volume with the actual volume. Then, adjust the volume injected accordingly.
- **Method 2 :** Use the TYPE M syringe and enter the new nl/sec number after recalculation.

NOTE: It may be necessary with some syringes to verify injections at different locations along the length of the syringe barrel as there can be variations along the inside length of the glass barrel.

Computer Control

RS232 commands are used to control the **Micro4** via the serial port of a computer.

RS232 Commands

All commands are case sensitive. The settings for the RS232 port are:

- 9600 baud rate
- 8 data bits
- 1 start bit
- 1 stop bit

Microsoft HyperTerminal settings:

- Flow control must be set to NONE
- Turn off echo characters locally
- Append line feeds
- Set character delay to 50ms under ASCII setup

Numbers and decimal points are indicated below by the “#” symbol.

Command	MICRO4 Display	Response (on Monitor)
V#####;	Sets the delivered volume. Number must have a decimal point and terminate with “;” (semicolon). See “Format of the Volume Command” on page 22.	
C#####;	Sets the volume counter. Number must have a decimal point and terminate with “;” (semicolon). See “Format of the Counter Command” on page 22.	
R#####;	Sets the delivery rate. Number must have a decimal point and terminate with “;” (semicolon). See “Format of the Rate Command” on page 22.	
I	Infuse mode	I
W	Withdraw mode	W
G	Go — Starts the syringe pump	G
H	Halt — Stops the syringe pump	H
S	Sets the rate units to nanoliters/second	S
M	Sets the rate units to nanoliters/minute	M
L#;	Line number — sets the syringe number on display (Micro4 only)	#_ (Number and space)
N	Not grouped mode	N
P	Grouped mode	O
D	Disabled mode (The line goes blank.)	P
Tx	Syringe Type. The letter indicating syringe type follows the T. For example, to select syringe type “A” the command is “TA”.	Letter of syringe type

RS232 Query Commands

All query commands begin with a question mark. Below is a list of the query commands. In the table below, “_” represents a space (20H).

Command	MICRO4 Display	Response (on Monitor)
?V	Returns the set volume	ex. 635.0_
?C	Returns the volume counter	ex. .0000_
?R	Returns the delivery rate	ex. 0015_
?X	Returns the maximum syringe rate	ex. +451_
?P	Returns the step rate (nL/step)	ex. .5868_
?T	Number of steps taken. NOTE: The nL/step cannot be programmed remotely	ex. +0_(infuse)_ -0_(withdraw) whole number of volume/nL/step
?1 or ?2	Returns T for true if the beeper is enabled	F=false
?3 or ?4	Returns T for true if the “press once to RUN the total volume” is true	H=false
?6 or ?7	Returns T for true if microstepping is enabled	F=false
?M	Returns a G for grouped mode, N for non-grouped mode, and D for disabled mode	
?S	Returns the letter of the syringe type	
?D	Returns the syringe pump direction: I =infuse, W =Withdraw	
?U	Returns the rate units: S =nL/second, M =nL/minute	
?G	Returns R if pump is running, S if pump is stopped	

Many of the commands are listed on the Help screen which appears when ?? is entered at the prompt in the HyperTerminal window (Fig. 15).

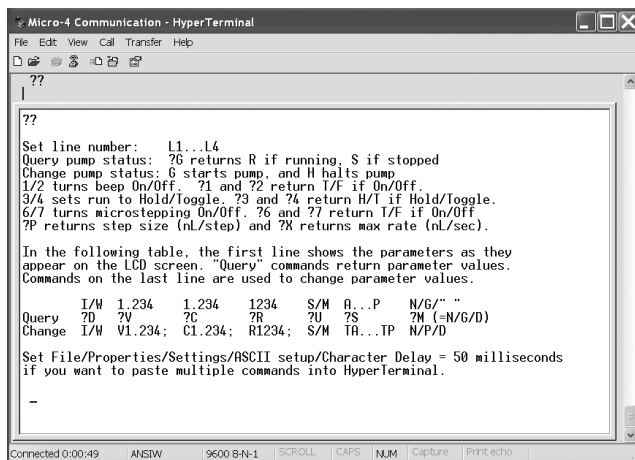

Fig. 15—The HyperTerminal Help window displays when you enter ?? at the prompt.

Troubleshooting RS232 Commands

When writing commands, please keep in mind the following guidelines:

- There is no set sequence to follow when issuing commands, but for logical programming purposes, use this format: L1;IV100.0;C0.0;TFR200.0;SN
NOTE: The syringe type "TF" is located before the rate setting command.
- Do not use spaces or line feeds. The carriage return (Enter) does not interfere.
- You should immediately see a response on the **Micro4** display from each entry as the ";" (semi-colon) is entered.
- The cursor channel indicator (the L#; command) must be on the pump channel that is being run. If the cursor is elsewhere, then the command will not function on other channels, unless the grouping is turned on (G last column).

Format of the Volume Command

The character field of V has a maximum of five numerals. A sixth character can only be the period (.). There is no requirement for a zero to the right of the decimal point. For example, you may enter V12345.; Then, type ?V to see the result echo on screen. The display will show "12345". The channel selected will show "12345" on the **Micro4** display as soon as the ";" character is typed. No more than two (2) numerals may follow the period (.), and the sixth character cannot be a number. So "V123.45;" is invalid, but "V123.4;" is valid.

Format of the Rate Command

The character field of R has a maximum of four numerals. A fifth character may be the decimal point (.). You cannot override the maximum number for the syringe type. For example, Type A is a 0.5 μ L syringe and has a maximum rate of 20nL/sec. Typing in a larger number (30nL/sec.) will still give you the maximum rate of 20nL/sec. The R value is rounded to the nearest whole number. For example, "R12.3;" becomes 0012 and "R12.5;" becomes 0013.

Format of the Counter Command

The character field of C has a maximum of five numerals. A sixth character may be the decimal point (.). This field should be entered as **C0.0**; This is the counter that determines how much more the syringe needs to move before it stops.

NOTE: Resetting this field to 0 may be required in certain conditions.

The **Micro4** Controller echos the following if issued the preceding command. In the table below, "_" represents a space (20H).

Command	MICRO4 Display	Response (on Monitor)
V123.4;	W123.4	123.4_
V12.34;	W12.34	12.34_
V12.;	W12.00	12.00_
V1.234;	W1.234	1.234_
V120;	W120.0	120.0_
V12345;	W12345	12345_
V123.45;	W1235	1235_ (This is not a legitimate entry. There are too many numerals.)
C1234;	1234.	1234._
C1234.;	1234.	1234._
R100.0;	0020SAN	0020_ (Type A rate restriction of 20nL/sec)
R100.0;	0100SFN	0100_ (Type F, 2035nL/sec maximum rate)
R1000.;	1000SFN	1000._
R1000.1;	1000SFN	1000._
R12.3;	0012SFN	0012_ (Rounded to whole number)
R12.5;	0013SFN	0013_ (Rounded to whole number)

Display Not Showing Programmed Values

If the volume and the rate cannot immediately be seen on the **Micro4** display, grouping may be turned off. The programmed units display comes up immediately on acceptance of the “;” transmission.

First, test the line number command. Watch for the cursor to move to the line and blink. When the final character “;” is entered, the display changes. If it does not, then apply a hard reset. (Power off the controller, turn it on and try again). All the parameters need to be entered for the pump to act properly. Blank fields are seen as unknowns and will most likely use a previously stored condition.

Non-Grouped Dispensing

The pump channel where the cursor is blinking is the only active program line that will activate and dispense fluid. To run multiple lines simultaneously:

- Group them.
- Change the line number to the channel and run them by separate commands. The channels are completely independent of each other (non-grouped).

Incorrect Volume Dispensed

The amount of volume actually dispensed was what was programmed on a prior programmed instance. To correct this, reset the counter. To do this, specify the C parameter as “C0.0;” with the volume and rate on a separate command line, just before issuing the G (go) command.

RS232 Cable Pinouts

To control the **Micro4** by computer, the RS232 cable must be configured as shown here:

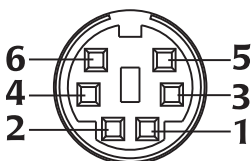

Fig. 16—Mini-DIN connector on rear panel of **Micro4** controller. **Micro4** cable with 9-pin connector is WPI #40500.

Signal	Micro4 Mini- DIN	9-Pin D-sub	25-Pin D-sub
Ground	5	5	7
UMC Data IN	3	3	2
UMC Data	4	2	3
OUT			
Run/ Stop	6	-	-
+5V pull up	2	-	-

Foot Switch Connections

Since the foot switch produces Run and Stop signals by connecting +5 volts (from pin 2) to pin 6, this port may also be used for TTL signals from other sources. The TTL pulse duration requires 50ms minimum.

MAINTENANCE

UMP requires minimal maintenance. Regular laboratory cleaning will keep this instrument in optimum operating condition.



CAUTION: Do not apply solvents or oils to any part of the **UMP3**.



CAUTION: This instrument is **not autoclavable**.



CAUTION: Do not disassemble—there are no serviceable parts inside either the **UMP3** or the **Micro4** controller.



CAUTION: Always hold the **UMP3** by the main body or mounting bar. Do not swing or carry the **UMP3** by its cable.



CAUTION: Use of gas-tight syringes on the **UMP3** is not recommended for syringes above 250 μ L as this can damage the motor. Please use liquid-tight syringes for applications that require volumes greater than 250 μ L.

Storage

Store the **UMP3** in a sealed plastic zip bag to prevent dust from accumulating on the drive screw. Excessive dust can cause jams and inadvertent stops.

Wet Autoclaving Syringes

Typically, Teflon syringes are not autoclavable, because the adhesives and the Teflon seal will eventually breakdown or swell from the heat and pressures involved. The most practical method of sterilizing is either gas or liquid chemical sterilization, but both require meticulous removal of the sterilizing agents prior to use.

If you are willing to replace the syringe after a few uses, then most syringes will stand up to a few cycles of wet autoclaving. The Teflon tipped plunger should be removed for this operation. Careful examination of any glued components and the Teflon tip integrity is required before reuse of an autoclaved syringe. If the Teflon tip cannot be replaced in the syringe body easily, then the plunger (tip) and perhaps the syringe requires replacement due to infusion of water. Autoclaving usually voids the warranty on Teflon-tipped syringes.

ACCESSORIES

Syringes



UMP3 is designed to be used with glass syringes having barrel diameters from 5.5 to 9mm. WPI's NanoFil™ gas-tight syringes are recommended for any microinjection application requiring high accuracy. The following data gives an overview of each type (NanoFil™ needles sold separately). Data presented also includes other models compatible with our UMP3:

Syringes with Beveled Needles

Order No.	Volume	Description	O.D. (mm)	Stroke length (mm)
NANOFIL	10 µL	10µL Fully Gastight System, 33-35G needles sold separately	6.4	60
NANOFIL-100	100 µL	100µL Fully Gastight System, 33-35G needles sold separately	7.75	60
SGE0005RN*	0.5 µL	0.5µL 23 ga (0.63 mm), 70mm long needle	8.0	54.1
SGE001RN*	1.0 µL	1.0µL 26 ga (0.47 mm), 70mm long needle	8.0	54.1
SGE005RN	5 µL	5µL 23 ga (0.63 mm), 50mm long needle	8.0	54.1
SGE025RN	25 µL	25µL 25 ga (0.50 mm), 50mm long needle	8.0	60
SGE050RN	50 µL	50µL 25 ga (0.50 mm), 50mm long needle	8.0	60
SGE100RN	100 µL	100µL 25 ga (0.50 mm), 50mm long needle	8.0	60

*The barrel length of this syringe is 17 cm long vs. 10 cm.

Replacement Needles

Order No.	Description
NF33BV/ NF33BL	For NanoFil™ Syringes, 33 ga BEVELED or BLUNT (40mm total fixture, injection needle length 10mm), 137mm total length installed within syringe barrel excluding plunger
NF34BV/ NF34BL	For NanoFil™ Syringes, 34 ga BEVELED or BLUNT (35mm total fixture, injection needle length 5mm), 127mm total length installed within syringe barrel excluding plunger
NF35BV/ NF35BL	For NanoFil™ Syringes, 35 ga BEVELED or BLUNT (35mm total fixture, injection needle length 5mm), 127mm total length installed within syringe barrel excluding plunger
NF36BV/ NF36BL	For NanoFil™ Syringes, 36 ga BEVELED or BLUNT (33mm total fixture, injection needle length 3mm), 125mm total length installed within syringe barrel excluding plunger
RN0005	For syringe SGE0005RN, 23 ga (0.63 mm) 70 mm long
RN001	For syringe SGE001RN, 26 ga (0.47 mm) 70 mm long
RN005	For syringe SGE005RN, 23 ga (0.63 mm) 50 mm long
RN025	For syringes SGE025RN, SGE050RN, SGE0100RN, 26 ga (0.47 mm) 50 mm long, 5-pack

Syringes with Luer Fitting (No Needle)

Order No.	Volume	Description	SCALE	
			O.D.	LENGTH
SGE050TLL	50µL	SGE 50µL Gas-tight Teflon Luer Lock	8.0 mm	60 mm
SGE100TLL	100µL	SGE 100µL Gas-tight Teflon Luer Lock	8.0 mm	60 mm
SGE250TLL	250µL	SGE 250µL Gas-tight Teflon Luer Lock	8.0 mm	60 mm

Use of gas-tight syringes above 250µL on the UMP3 is not recommended. Please use liquid-tight syringes for applications that require volumes greater than 250µL.

Hamilton is a trademark of Hamilton Co., SGE is a trademark of Scientific Glass Engineering, ILS is a trademark of Innovative Labor Systeme.

Additional Accessories

13142 Foot switch for MICRO2T

UMP3 UltraMicroPump 3

Replacement Parts

300630 Mounting Bar, 4.3"

65085 Mounting Bar Locking Nut

65141 Plunger Retaining Screw

TROUBLESHOOTING

Issue	Possible Cause	Solution
Instrument motor makes noise, but plunger button does not travel.	Loose connection	Look for a loose connector at the rear of the Micro4 , make sure the UMP3 plug is firmly seated. The gray plastic plug should be a flush fit with the connector on the controller. Verify that the pins in the connector are not damaged.
	Channel is improperly programmed	Test the pump in another channel, with the same program parameters.
Pump is jammed.	Plunger button has traveled to the extreme edge of the pump and has jammed	<ol style="list-style-type: none"> 1. Place the pump so that the syringe points to the right. 2. Remove the syringe. 3. Program the Micro4: Syringe style F (or larger to H), 2000–5000nL volume, rate of ≥ 2000. 4. Press and hold the right or left arrow key for the direction you want the plunger holder to move in. Quickly tap the RUN/STOP key a couple times to unwind the drive screw tension and move the plunger holder away from the end of its travel. 5. Apply a slight pressure on the plunger carrier in the direction the pump is programmed to move. This can cause mechanical damage to the internal carrier if $>200\text{g}$ of force is used. <p>If the holder cannot be moved away from the stop end easily by this method, then contact techsupport@wpiinc.com for assistance. The pump may have to be returned for mechanical disassembly to correct this.</p>
Pump stalling. Motor can't push syringe plunger.	More than 400g is required to push the syringe plunger.	The syringe should not be a gas-tight (<i>i.e.</i> , Teflon-sealed) piston greater than 250mL in volume. This syringe type requires more force than the motor can push. If you require a large volume syringe (over 250 μL), use a liquid-tight plunger.

Issue	Possible Cause	Solution
Pump stalling. Motor can't push syringe plunger.	Needle blockage	The micropipette or the needle might be blocked by a tissue mass in or outside of the needle, or the needle tip may be too small for the programmed injection. Check for normal operation of the pump in air with and without the syringe attached. Too high a delivery rate through a tip that is too small can cause tissue damage and overtax the pump.
	Syringe misalignment	The syringe must be axially aligned to the UMP3 body in the clevises, and the syringe plunger button must be centered in its holder to properly inject along the length of the syringe. A small misalignment of the syringe plunger can cause pulsating waves in the injection and an incorrect amount of delivery.
	Mechanical damage	If the UMP3 plunger carrier is loose (a condition which can be caused by overtravel), the pump must be returned to WPI for repair.

NOTE: If you have a problem/issue that falls outside the definitions of this troubleshooting section, contact the WPI Technical Support team at 941.371.1003 or technicalsupport@wpiinc.com.

SPECIFICATIONS

This unit conforms to the following specifications:

UMP3

Travel	62mm
Minimum Dispensing Volume	0.58nL/step (syringe dependent — see “Fig. 10—The volume counter field shows the real-time volume that has been delivered on each channel.” on page 11)
Linear Motion	3.175µm/step
Plunger Position Error	< 0.5%
Pump Force	400g
Syringe Diameters	5.5 to 9.0mm
Maximum Step Rate.....	700 steps/sec (depending on syringe)
Weight	325g (11.4 oz.)
Size	Ø 32mm x 190mm (Ø 1.3 in. x 7.5 in.)
Power Requirements	12VDC 2A, provided by Micro4

Micro4 Controller

Power Requirements	12V (1.6A)
Dimensions	12.7 x 15.2 x 8.9cm (5 x 6 x 3.5 in.)
Power Requirements ..	12 VDC from auto-switchable power supply (100-240 VAC input)

NanoFil Syringes

Syringe Order Code	Volume	Syringe Type	Syringe Body	Autoclavable/ Gas Sterilizable	Plunger Stroke Length	Plunger Cap Dimensions	Syringe Barrel I.D./O.D.*	Qty	MICRO4/ MICRO2T Syringe Type Selection
NANOFIL	10µL	Gas-tight	Borosilicate glass, Stainless Steel, PTFE	Yes ✓ 10°C/50°F to 80°C/176°F, 1000psig max pressure	60mm	O.D.*: 7.90mm (0.311in) Depth: 2.80mm (0.110in)	0.46mm (0.018in)/ 6.40mm (0.252in)	1 EA	L (MICRO4) 5 (MICRO2T)
NANOFIL-100	100µL						1.46mm (0.057in)/ 7.75mm (0.305in)	1 EA	

*I.D. = Inner diameter, O.D. = Outer diameter

NanoFil Needles

Order No.	Tip O.D.	Tip I.D.	Tip Length	Total Length	Shank O.D.	Bevel Length	Tip Material
NF33BV	210 µm	115 µm	10 mm	40 mm	460 µm	≈348 µm	Stainless Steel
NF34BV	185 µm	85 µm	5 mm	35 mm	460 µm	≈290 µm	Stainless Steel
NF35BV	135 µm	55 µm	5 mm	35 mm	460 µm	≈204 µm	Stainless Steel
NF36BV	120 µm	35 µm	3 mm	33 mm	460 µm	≈156 µm	Stainless Steel
NFQ34-5	160 µm	100 µm	55 mm	75 mm	460 µm	n/a	Quartz
NF33BL	210 µm	115 µm	10 mm	40 mm	460 µm	0	Stainless Steel
NF34BL	185 µm	85 µm	5 mm	35 mm	460 µm	0	Stainless Steel
NF35BL	135 µm	55 µm	5 mm	35 mm	460 µm	0	Stainless Steel
NF36BL	120 µm	35 µm	3 mm	33 mm	460 µm	0	Stainless Steel
Silflex		100 µm		35 cm			
NF26BV	460 µm	140 µm		40 mm	460 µm		Stainless Steel

REFERENCES

S.B. Mazzone, D.P. Geraghty "Respiratory actions of tachykinins in the nucleus of the solitary tract: effect of neonatal capsaicin pretreatment" (2000) *British Journal of Pharmacology* **129**:6 pp1132-1139.

B.L. Davidson, C.S. Stein, J.A. Heth, I. Martins, R.M. Kotin, T.A. Derksen, J. Zabner, A. Ghodsi, J.A. Chiorini "Recombinant adeno-associated virus type 2, 4, and 5 vectors: Transduction of variant cell types and regions in the mammalian central nervous system" (2000) *Proceedings of the National Academy of Sciences of the United States of America* **97**:7 pp3428-3432.

A.I. Brooks, et al. "Reproducible and Efficient Murine CNS Gene Delivery Using a Microprocessor Controlled Injector" (1998) *Journal of Neuroscience Methods* **80** pp 137-147.

APPENDIX A: SYRINGE CONSIDERATIONS

Special Syringe Considerations ILS005

The **UMP3-Micro4** was designed around 60mm or 54.1mm syringes. The full injection of a 5 μ L syringe is expected to be a 60mm movement. In the case of the **ILS005** special 5 μ L glass luer tip syringe, this length is 27mm for an injection of 5 μ L.

You have a choice for programming the **Micro4**.

1. Program the Micro4 syringe type using one of these two options:
 - Program the **Micro4** for a Type C syringe (the 54.1mm 5 μ L syringe). Multiply the volume to be injected by 27/54.1 or (0.4990). For example, enter a 2500nL injection using type C into the **Micro4** as 1247.5 nL. ($2500 \times 0.4990 = 1247.5$) This value can be further calibrated. See "Calibrating a Syringe" on page 19.
 - Program the **Micro4** for a Type M syringe. Divide the Type C nL/step number by 0.4990. For example, the standard 54.1mm syringe has a value of 0.2934nL/step on a 5 μ L syringe. The **ILS005** has a 27mm stroke for this same full volume. $0.2934/0.4990 = 0.5880$ is the nL/step value to program. See below. (0.5880 is also verified by the formulas on page 16.)
2. After defining your syringe, move the cursor to the Device Type field of the output channel where that pump is connected and press **SELECT** until **M** appears.
3. Any number of channels may use type **M** syringes, but since a single definition for type **M** is stored in **Micro4**, all **M** devices must be identical. (That is, you cannot use two non-standard types, such as 2.5 μ L and 0.25 μ L.)

NOTE: The minimum delivered volume depends on the syringe size and is listed in the syringe type table (page 11) under nL/step. The actual volume delivered is divisible by the volume per step. For example, using a syringe with a volume per step of 1nL, actual delivered volume for the given set volume is listed below.

Volume Set	Actual Volume Delivered
0-0.9999nL	0
1 nL-1.999nL	1nL
2 nL-2.999nL	2nL

Hamilton 7000 Series

Volume (μ L)	ID (mm)	nL/Step	TYPE
0.5	0.1030	0.0265	User defined
1.0	0.1457	0.0529	User defined
2.0	0.2060	0.1058	User defined
5.0	0.3257	0.2645	User defined

Using Teflon Tipped Syringes

Carefully remove the plunger and its Teflon tip by drawing it out of the syringe barrel.

1. Before inserting the plunger tip into the syringe, pre-wet the Teflon plunger tip and the syringe body interior with water.



CAUTION: Use care in inserting the plunger into the syringe, because the plunger rod may be easily bent.

2. Carefully place the plunger tip into the syringe and gently work the tip down into the body of the syringe using a thumb and forefinger to grasp and push small lengths of the plunger rod into the syringe. Repeat this procedure until the plunger tip is near the zero mark of the syringe.
3. Draw additional water into the syringe and slowly work the plunger up and down until the plunger tip is cold formed into the syringe and the stiffness goes away. The stiffness of the new plunger tip may require you to move the rod in small increments until the tip is formed enough to actuate by the rods full length.

APPENDIX B: NANOLITER 2010/MICRO4 VOLUME SETTINGS

When using the **Micro4** to control injections with the **Nanoliter 2010**, take care when entering the injection volume. The **Nanoliter 2010** injector's volume per step is based on the movement of the plunger wire inside a pulled glass pipette. This plunger moves 0.0005" (12.7 μ m) for each step of the motor. The volume of 2.3nL/step is based on the inside diameter of a 0.5mm pipette and the 12.7 μ m movement of the plunger wire.

Setting the Correct Volume on the Micro4

Since the volume per step is 2.3nL, the volume to be entered on the **Micro4** touch panel must be a multiple of 2.3.

For example, to inject 100nL, the setting on the **Micro4** panel is calculated as $100/2.3$ or 43.47 steps. The motor can only step in whole numbers, so the volume must be adjusted, up or down, to the nearest whole step value.

- Increasing to 44 steps times 2.3 gives a volume of 101.2nL.
- Decreasing to 43 steps times 2.3 gives a volume of 98.9 nL.

One of these two volumes should be used to insure a proper injection. Leaving the value on the **Micro4** at 100nL results in a 98.9nL injected.

Difficulty can arise when the volume value is half or more of the next 2.3nL step. For example, setting the **Micro4** for an injection of 10nL results in an actual injection of 9.2nL, produced by 4 whole steps of the injector. 5 whole steps results in 11.5nL injected. Entering a value of 11.0nL in the controller, however, generates a spurious value in the **Micro4** display — 10.35nL, but the actual injection is still only 9.2nL. To avoid this error, enter only multiples of 2.3nL when calculating required volumes.

APPENDIX C: MICRO-STEPPING

The **UMP3** has two user-selectable stepping modes. Each mode has both advantages and disadvantages. For instructions on how to change stepping modes, see “Setting Infuse/Withdraw” on page 9. For a brief overview of this appendix, see “APPENDIX C: Micro-stepping” on page 34.

Let’s define a few terms:

- **Volume per step:** For a given stepping mode and syringe size, this is the minimum volume increment that can be delivered by the **UMP3**.
- **Step Angle:** The minimum rotational movement possible for a stepper motor, usually expressed in degrees.
- **Stator:** A mechanically fixed set of electromagnetic coils arranged in a circumference on the inside diameter of the motor housing. The rotor is positioned within the field coils of the stator.
- **Rotor:** A permanent magnetic structure bonded to the drive shaft of the motor. The poles of the rotor magnets react with the electro-magnetic field generated in the stator, which forces the rotor to move.
- **Normal Mode:** In Normal mode, the minimum step angle of the **UMP3** is determined by half-stepping at 3.75° . This rotational movement is translated through the drive screw to be about $3.18\mu\text{m}$ of linear travel at the push block.
- **Microstepping mode:** In Microstepping mode, the minimum step angle is conservatively rated at approximately 0.47° , and this translates to a linear motion at the push block of about $0.40\mu\text{m}$ of linear travel at the push block.

Brief Operational Theory of Stepper Motors

The **UMP3** drive system utilizes a bipolar stepper motor in an open loop configuration. A stepper motor converts electrical impulses into rotational movement. A stepper motor is a good choice for open loop applications, because its rotational movement can be controlled in discrete increments that are precise, and repeatable. A stepper motor has a number of electromagnetic coils or “poles” that are arranged in a circle around the drive shaft. Generally speaking, the number of these “poles” determines the rotational resolution of the movement. The circle of electro-magnetic coils is collectively known as the **stator**. Centered within the stator is a permanent magnet that is attached to a rotational shaft called the **rotor**. The rotor is connected to the lead screw, which is coupled to the push block and converts rotational motion into the linear drive necessary to move the syringe plunger.

When a single or opposing pair of the stator coils is energized, the magnetic poles of the rotor magnet move to align themselves with the energized coils. In practice,

multiple coils are energized in a sequence by the motor drive circuitry, resulting in a rotational force on the rotor, which drives the lead screw.

In a “normal” step sequence, when the motor is stopped, the magnetic poles of the rotor align themselves on axis with the plus and minus poles of the energized stator coils. However, it is possible to align the rotor BETWEEN the poles of two stator coils. This is known as half-stepping. Half-stepping is accomplished by using standard position control techniques in the motor drive circuit. By controlling the relative phases of currents within the stator coils, an electromagnetic equilibrium is created so that the rotor is held in position between stator poles. In half-stepping, the rotor is positioned halfway between two stator coils, and this effectively reduces the step angle of the rotor by $1/2$, allowing a smaller step increment for injection.

Using additional techniques, it is possible to achieve even finer sub-steps at $1/4$, $1/8$, $1/16$ or even $1/64$ of a step. This is referred to as microstepping. Although microstepping provides certain advantages, its implementation involves tradeoffs in torque, rotational speed and precision. As a consequence, the dominant performance characteristics required for a given experiment should be considered before using the Microstepping mode on the **UMP3**.

Advantages of Microstepping

- Microstepping is useful for smoothing out undesirable pressure pulses that may be experienced in normal step mode when injecting a very small volume or for injections that are performed over extended periods of time.
- Microstepping offers improved precision when injecting a volume that is close to or less than the minimum volume per step in normal mode.
- The **UMP3** is quieter and has reduced vibration in micro-stepping mode than it does in normal step mode.

Disadvantages of Microstepping

- Reduced torque. The microstepping technique results in reduced torque on the leadscrew. This can be as much as a 15–30% reduction based on the step rate. The higher the step rate, the more the torque is reduced. For applications that demand maximum torque, such as when using a large volume gas tight syringe, microstepping is not the best choice.
- Reduced speed. The microstepping mode operates at 15 times slower speed than the normal stepping mode.

When Should I Microstep?

Microstepping should be used when the calculated **volume per step** in normal mode is

larger than the desired volume to be injected, or when the volume per step in the normal mode causes undesirable pressure pulsations when injecting at a low rate. Determining when pressure pulsations become undesirable is subjective, based on the requirements of your application. However, if 5 or fewer minimum step volumes are injected per second, the injection can be considered pulsatile.

The examples below use calculations to illustrate the difference between microstepping and normal stepping. The first example shows the calculations for normal stepping mode, and the second shows the calculations for microstepping mode.

Normal Stepping Example Calculations

In our experiment, we require the injection of 1nL from a 10µL syringe with a 60mm stroke length. From the **UMP3** specifications, we know that the minimum linear step size in normal mode is 3.175µm/step. Using this information and the scale volume of the syringe, we calculate the minimum volume per step for normal mode in nL:

1. Calculate the volume per distance traveled for the syringe in nL/step:

$$\frac{3.175\mu\text{m}}{\text{step}} \times \frac{1\text{mm}}{1000\mu\text{m}} \times \frac{10\mu\text{L}}{60\text{mm}} \times \frac{1000\text{nL}}{1\mu\text{L}} = \frac{0.529\text{nL}}{\text{step}}$$

2. Calculate the number of steps required to inject the desired volume.

It's important to understand that the **UMP3** can only inject whole values of the minimum step volume, and will always perform the maximum number of steps possible to approximate the desired volume *without going over the target volume*.

$$\frac{1\text{nL}}{0.529\text{nL/step}} = 1.89 \text{ steps}$$

Remembering that the **UMP3** can only inject the entire volume of the minimum step increment without going over the target volume, we see that one step increment injects 0.529nL, and that two step increments inject (2 × 0.529nL) = 1.058nL. Since 1.058nL exceeds the target value of 1nL, only one step increment is performed, and the injected amount using the normal step mode is 0.529 nL.

Microstepping Example Calculations

Let's perform the same calculations as above for injection of 1nL from a 10µL syringe with a 60mm stroke length using microstepping. From the **UMP3** specifications, we know that the minimum linear step size in microstepping mode is 0.4µm/step. Using this information and the scale volume of the syringe, we can calculate the minimum volume per step for microstepping mode in nL:

1. Calculate the volume per distance traveled for the syringe in nL/step:

$$\frac{0.4\mu\text{m}}{\text{step}} \times \frac{1\text{mm}}{1000\mu\text{m}} \times \frac{10\mu\text{L}}{60\text{mm}} \times \frac{1000\text{nL}}{1\mu\text{L}} = \frac{0.067\text{nL}}{\text{step}}$$

2. Calculate the number of steps required to inject the desired volume.

$$\frac{1\text{nL}}{0.067\text{nL/step}} = 14.93 \text{ steps}$$

Remembering that the **UMP3** can only inject aliquots of the minimum volume per step without exceeding the target volume, we can calculate that with 14 microstep increments, we inject 0.94nL, which does not exceed the target value of 1nL. In this example, using microstepping more closely approximates the target volume than the normal step mode.

DECLARATION OF CONFORMITY



WORLD PRECISION INSTRUMENTS, INC.

175 Sarasota Center Boulevard
Sarasota, FL 34240-9258 USA
Telephone: (941) 371-1003 Fax: (941) 377-5428
e-mail wpi@wpiinc.com

DECLARATION OF CONFORMITY

We: World Precision Instruments, Inc.
175 Sarasota Center Boulevard
Sarasota FL 34240-9258
USA

as the manufacturers of the apparatus listed, declare under sole responsibility that the product(s):

Title: UMC4

to which this declaration relates is/are in conformity with the following standards or other normative documents:

Safety: EN 61010-1:1993 (IEC 1010-1:1990)

EMC: EN 50081-1:1992
EN 50082-1:1992

and therefore conform(s) with the protection requirements of Council Directive 89/336/EEC relating to electromagnetic compatibility and Council Directive 73/23/EEC relating to safety requirements.

Issued on: 18th February 2009

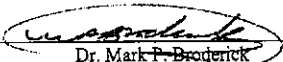
Dr. Mark P. Brodenick
President and COO

World Precision Instruments, Inc.
175 Sarasota Center Boulevard
Sarasota, FL 34240-9258 USA

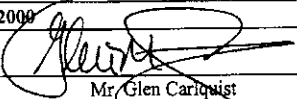
Mr. Glen Carlquist
Production Manager

World Precision Instruments, Inc.
175 Sarasota Center Boulevard
Sarasota, FL 34240-9258 USA



WORLD PRECISION INSTRUMENTS, INC.

175 Sarasota Center Boulevard
 Sarasota, FL 34240-9258 USA
 Telephone: (941) 371-1003 Fax: (941) 377-5428
 e-mail wpi@wpiinc.com

DECLARATION OF CONFORMITY

We: World Precision Instruments, Inc.
 175 Sarasota Center Boulevard
 Sarasota FL 34240-9258
 USA

as the manufacturer of the apparatus listed, declare under sole responsibility that the product:



Title: ULTRA MICRO PUMP 3 (UMP 3)

to which this declaration relates is in conformity with the following standards or other normative documents:

- Safety:** EN 61010-1:2001
- EMC:** EN 61326-1: 2006
 EN 55011: 1998 + A2: 2002
 EN 61000-3-2: 2000
 EN 61000-3-3: 2001
 EN 61000-6-2: 2001

and therefore conforms with the protection requirements of Council Directive 2004/108/EC relating to electromagnetic compatibility and Council Directive 73/23/EEC relating to safety requirements.

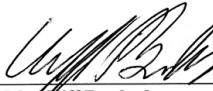
Issued on: February 23, 2007

 <hr style="width: 100%;"/> <p>Mr. Cliff Bredenberg General Manager World Precision Instruments, Inc. 175 Sarasota Center Boulevard Sarasota, FL 34240-9258 USA</p>	 <hr style="width: 100%;"/> <p>Mr. Glen Carlquist Vice President of Manufacturing World Precision Instruments, Inc. 175 Sarasota Center Boulevard Sarasota, FL 34240-9258 USA</p>
--	--



INDEX

Symbols

13142 26
15867 6
65085 26
65141 26
300630 26

A

Accessory Kit 3
alignment 6
analytical balance 19
arrow keys 8
autoclavable 24
autoclave 2

B

beeper 21
blockage 28

C

cable connector 4
calibrate 10, 19
Cidex 2
clamp release 4
collar stop 4, 6
collar stop clamp 6

D

data/save 8
delivery rate 20, 21
device type 13
disassemble 24
display 23

E

electro-magnetic coils 34
error 7

F

foot switch 2, 6, 24

G

gas-tight syringes 14, 24, 26, 27
group 15, 21

H

half-stepping 35
Hamilton 26
help 21

hydrated oil droplet 19
HyperTerminal 20, 21

I

ILS005 31
Infuse 9

K

keypad 9

L

lead screw 35
LEDs 8
liquid-tight syringe 27
liquid-tight syringes 24, 26

M

maximum syringe rate 21
Micro4 3
micrometer 19
microstepping 21, 34
misalignment 28
mounting bar 4, 5

N

Nanoliter 2010 33
non-group 15
non-grouped 23

O

oil 24

P

parts list 3
plunger button holder 4
plunger carrier 28
plunger retaining screw 4, 6
power supply 6
pulsations 36

R

rate 12, 21
rate of infusion 12
rate units 13
reticle 19
returns 3
RN001 26
RN0005 26
RN025 26
rotor 34

RS232 2, 6, 20, 21, 22, 24
Run/Stop 9

S

select 9
set volume 21
SGE 26
SGE001RN 25
SGE0005RN 25
SGE025RN 25
SGE050RN 25
SGE050TLL 26
SGE100RN 25
SGE100TLL 26
SGE250TLL 26
solvents 24
stator 34
step angle 34
steps 21
sterilize 25
storage 25
syringe clamps 4
syringes 6, 7, 14, 24
syringe stroke length 15

T

Teflon tip 32
torque 35
troubleshooting 27
TTL 2, 24
type M 31

U

UMP3 26
unpacking 3

V

volume 20
volume counter 11, 20, 21
volume set 10

W

withdraw 9

WARRANTY

WPI (World Precision Instruments, Inc.) warrants to the original purchaser that this equipment, including its components and parts, shall be free from defects in material and workmanship for a period of one year* from the date of receipt. WPI's obligation under this warranty shall be limited to repair or replacement, at WPI's option, of the equipment or defective components or parts upon receipt thereof f.o.b. WPI, Sarasota, Florida U.S.A. Return of a repaired instrument shall be f.o.b. Sarasota.

The above warranty is contingent upon normal usage and does not cover products which have been modified without WPI's approval or which have been subjected to unusual physical or electrical stress or on which the original identification marks have been removed or altered. The above warranty will not apply if adjustment, repair or parts replacement is required because of accident, neglect, misuse, failure of electric power, air conditioning, humidity control, or causes other than normal and ordinary usage.

To the extent that any of its equipment is furnished by a manufacturer other than WPI, the foregoing warranty shall be applicable only to the extent of the warranty furnished by such other manufacturer. This warranty will not apply to appearance terms, such as knobs, handles, dials or the like.

WPI makes no warranty of any kind, express or implied or statutory, including without limitation any warranties of merchantability and/or fitness for a particular purpose. WPI shall not be liable for any damages, whether direct, indirect, special or consequential arising from a failure of this product to operate in the manner desired by the user. WPI shall not be liable for any damage to data or property that may be caused directly or indirectly by use of this product.

Claims and Returns

Inspect all shipments upon receipt. Missing cartons or obvious damage to cartons should be noted on the delivery receipt before signing. Concealed loss or damage should be reported at once to the carrier and an inspection requested. All claims for shortage or damage must be made within ten (10) days after receipt of shipment. Claims for lost shipments must be made within thirty (30) days of receipt of invoice or other notification of shipment. Please save damaged or pilfered cartons until claim is settled. In some instances, photographic documentation may be required. Some items are time-sensitive; WPI assumes no extended warranty or any liability for use beyond the date specified on the container

Do not return any goods to us without obtaining prior approval and instructions from our Returns Department. Goods returned (unauthorized) by collect freight may be refused. Goods accepted for restocking will be exchanged or credited to your WPI account. Goods returned which were ordered by customers in error are subject to a 25% restocking charge. Equipment which was built as a special order cannot be returned.

Repairs

Contact our Customer Service Department for assistance in the repair of apparatus. Do not return goods until instructions have been received. Returned items must be securely packed to prevent further damage in transit. The Customer is responsible for paying shipping expenses, including adequate insurance on all items returned for repairs. Identification of the item(s) by model number, name, as well as complete description of the difficulties experienced should be written on the repair purchase order and on a tag attached to the item.

** Electrodes, batteries and other consumable parts are warranted for 30 days only from the date on which the customer receives these items.*



WORLD
PRECISION
INSTRUMENTS